

For Installer



Assembly Guide Continental Bifold

Contents

<u>Title</u>	<u>Page Number</u>
Handling Manual Blinds	3
Handling Electronic Blinds	4
Drainage	5
Outer Frame Assembly (Kit Form Door Only)	6
Low Threshold Assembly	7
Hinges	8
Gasket Positions	9-10
Traffic Door Magnet Retainer	11
Toe & Heeling	12-19

Call 01268 681612 for advice & fitting support

Essential Instructions

CILL - HEAD - JAMBS must be fitted dead level and square or doors will not operate correctly. Make sure the doors are toe and heeled correctly. See pages 12-19

Manual Blinds

Handling and Installation Sheet For Manual Push Block Integrated Blinds

Blinds are manufactured with all slats closed at the head track; on **NO** account should they be tilted or lowered until the unit is correctly installed in the frame.

Blind units should be transported either with the closed slats at the top or bottom of the unit, they can be transported on their sides with care. On **NO** account should they be laid flat.

All blind units are gas filled and fully operational before being dispatched.

The operating system is powered by magnets and on **NO** account should the magnet controllers be removed from the glass surface until the unit is installed correctly in the frame.

When operating for the first time, lower the blind to its full extent, using the tilt controller; always ensure that the slats are in the horizontal position before using the lift and drop controller.

The controllers should not be forced beyond their magnetic connection and are not interchangeable.

When the unit is in the frame and before the final bead and gasket is applied, select the operating position for the controllers, these need to be in alignment with the blind jamb sections.

These procedures are to assist in the transportation, installation and operation of these products.

DURATION WINDOWS CANNOT ACCEPT RESPONSIBILITY FOR PRODUCT FAILURES IF THE INSTALLATION INSTRUCTIONS HAVE NOT BEEN FOLLOWED AND UNITS HAVE BEEN INSTALLED INCORRECTLY.

Electronic Blinds

Handling and Installation Sheet For Electronic Control Unit Integrated Blinds

Blinds are manufactured with all slats closed at the head track; on **NO** account should they be lowered until the unit is correctly installed in the frame.

All blind units are gas filled and **fully operational** before being dispatched.

The battery controller is powered to capacity at manufacture but should be re-charged on site before attempting to operate the blind.

The battery controller power source should be charged as required from the UK mains house supply, this supply is reduced to 12 volts for safe operation.

Each unit will have a short cable exiting at the side of the head track, a female connector is attached and a longer cable is attached to the power plate with a male connector.

When the unit is in the frame and before the final bead and gasket is applied, select the operating position for the controller before applying the power plate to the glass.

The blinds power plate should be fixed to the internal glass surface, the glass must be cleaned before applying the self adhesive power plate.

The fully charged controller should be placed on the power plate, the controller is held in place by magnetic force.

DURATION WINDOWS CANNOT ACCEPT RESPONSIBILITY FOR PRODUCT FAILURES IF THE INSTALLATION INSTRUCTIONS HAVE NOT BEEN FOLLOWED AND UNITS HAVE BEEN INSTALLED INCORRECTLY.

Drainage

When installing a bifold, drainage paths for the threshold need to be taken into consideration.

Please discuss drainage with the installer, homeowner and installer of the external flooring.

The below images depict an example of each threshold and its drainage path.

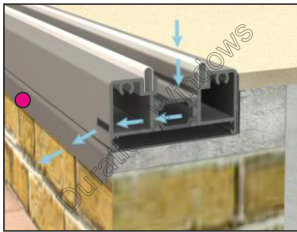

Low Threshold

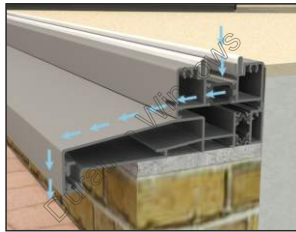

Low Threshold With Cill

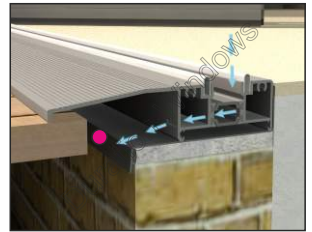

Duration Threshold (With ramp)

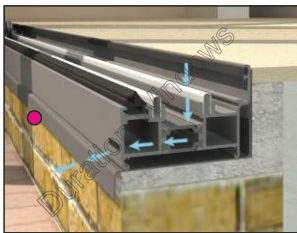

Standard Threshold (Open out)

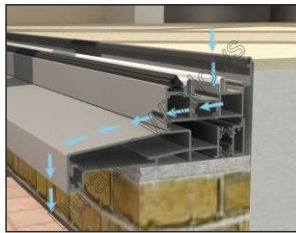

Standard Threshold With Cill (Open out)



Standard Threshold (Open in)

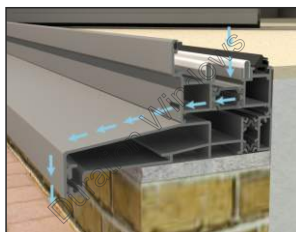

Standard Threshold With Cill (Open in)

● Lead Flashing or DPC
Supplied By Others.

Images displayed on this page are to show drainage paths only. They are not a guide on good building practice.

Outer Frame Assembly

This page is only required when the bifold has been ordered in kit form.

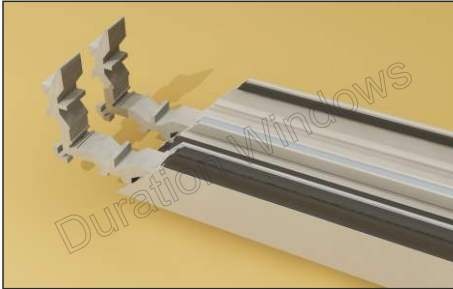

Image to the left shows the positioning of the cleats once in the frame.

Use a 3mm allen key to tighten inserted blocks.



Make sure the mitre is sealed with silicone or small gap sealer before assembling.



Insert the blocks with the allen key screw facing the round hole. Use a 3mm allen key to tighten up the mitre. Make sure you have sealed the mitre with silicone or small gap sealer.



Image shows how the mitre will look once assembled correctly.

Low Threshold Assembly

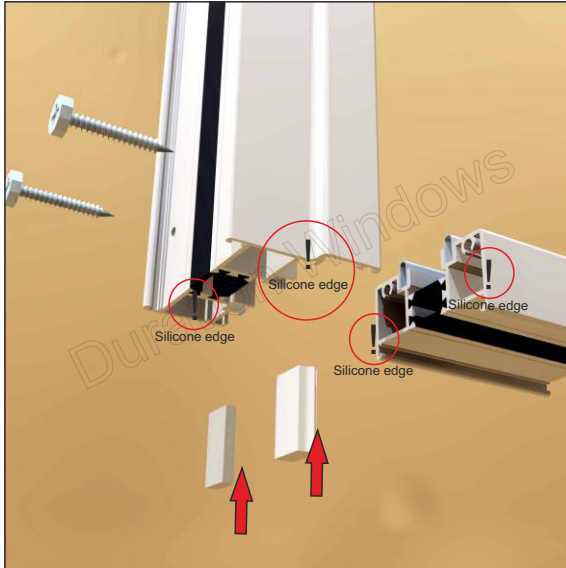

Position low threshold up against the rebated frame.

Make sure to silicone edges.

Insert jamb plugs into the rebated frame.

Make sure to silicone edges.

Tighten fixings evenly.

Important:

Remember to silicone each corner joint before final fix.

Once assembled finally pump silicone into any spaces between the threshold and frame.

When fitting a cill with this style of threshold you may be required to notch out an area for the rebate to fit into. (Below)

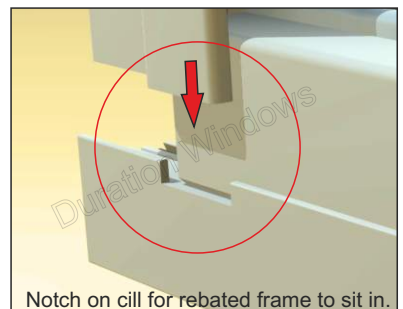

Notch on cill for rebated frame to sit in.

Hinges

Hinge

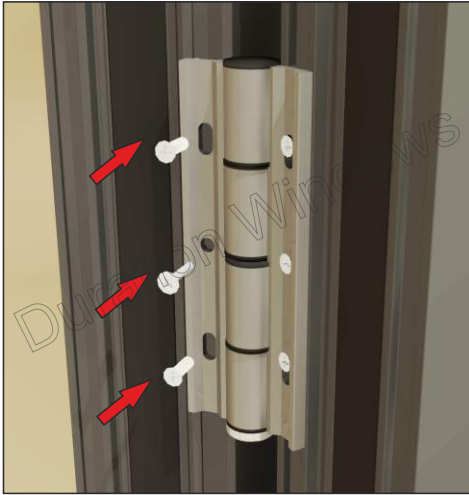

The holes for the hinges will have been pre-drilled at the factory.

Line up hinges and machine screws with the pre-drilled holes on the back plate.

Insert top and bottom machine screws first.

Line door up level to the top and bottom of the frame.

Check doors are all level.

Finally once door is all level add the final fix self taper screw to the centre of the hinge.

Bogie Hinge

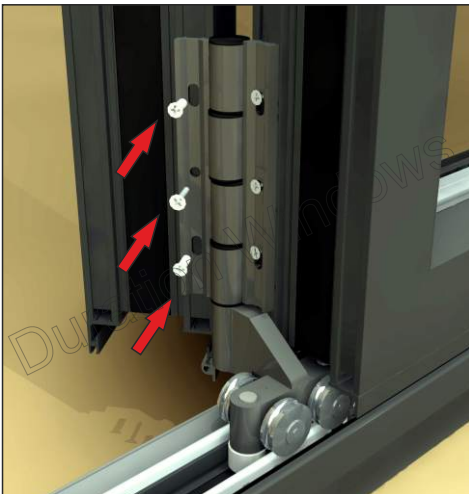

Guide Hinge

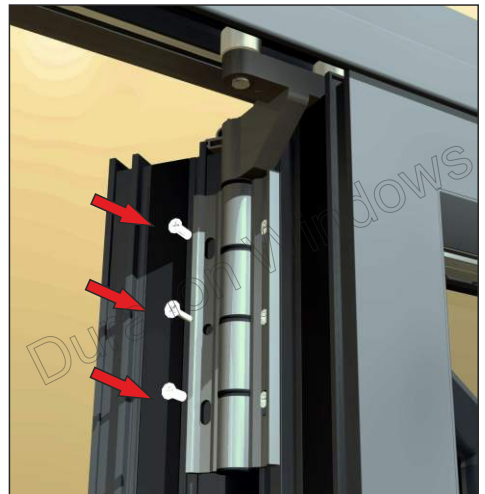

Gasket Position

Traffic Door & Mullion Cut Through

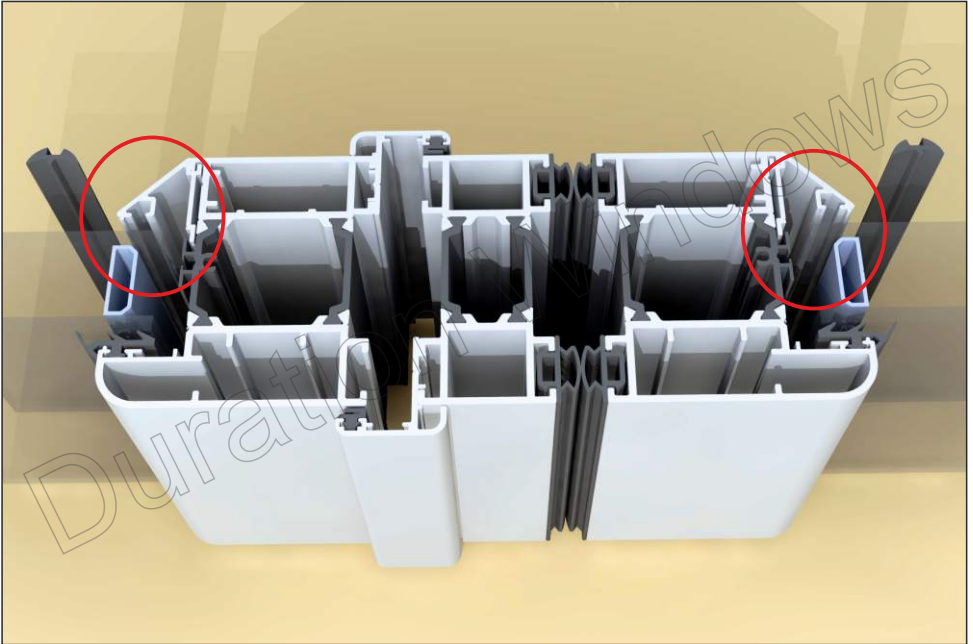

Insert wedge gaskets into positions shown once units are glazed into the door (shown by red circles).

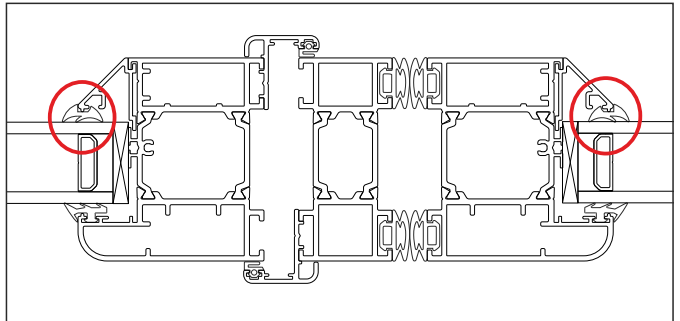

Gasket Position

Top Section Cut Through

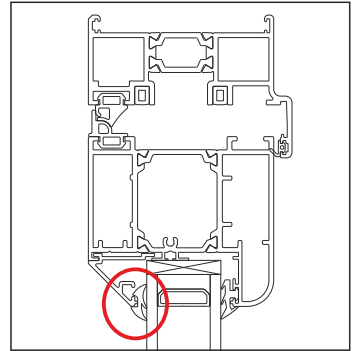
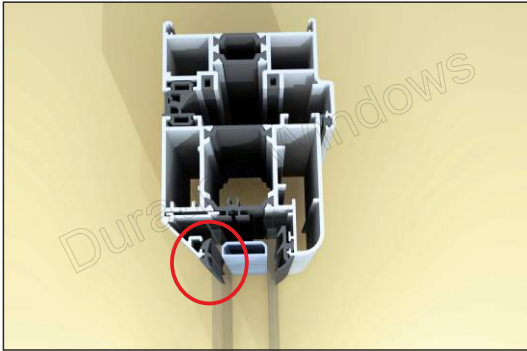

Side Cut Through

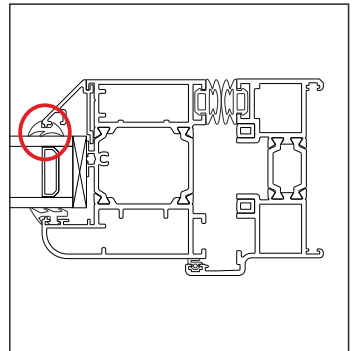
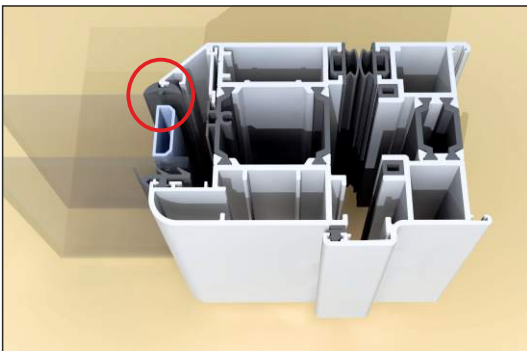

Gaskets supplied already in place:

- AB614 (Sash)
- RX612 (Outer frame)
- AF614 (Sash)
- RX615 (Sash bottom)
- RX611 (Outer frame track filler)
- AGS240 (E gasket)
- ACVL032 (Rebate gasket)

Gaskets supplied loose:

- AGS305 Wedge gasket

Traffic Door Magnet Retainer



Image shows the pair of door retainer magnets in your box.



The screw goes through the centre of the magnet.



Slide cover over the magnet and screw.

(for configurations with traffic doors)

Magnet Position on Traffic Door

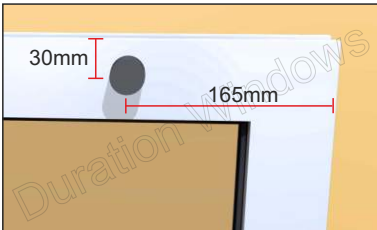

Magnet width position: 165mm
Magnet height position: 30mm

Magnet Position on Folding Panel



Magnet width position: 165mm
Magnet height position: 30mm

Magnets Function

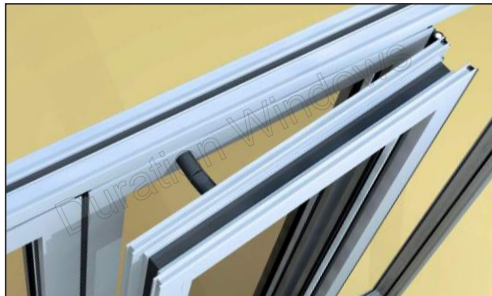

The magnets are used where traffic or slave doors fold back onto an adjacent panel and are designed to stop the doors and handles colliding with each other.

Toe & Heeling

Important Glazing Instructions

In order for all products to work correctly this sealed unit must be correctly glazed.

Bi-folding doors must be correctly toe & heeled.

*Example Shown Below
Viewed from the Inside*

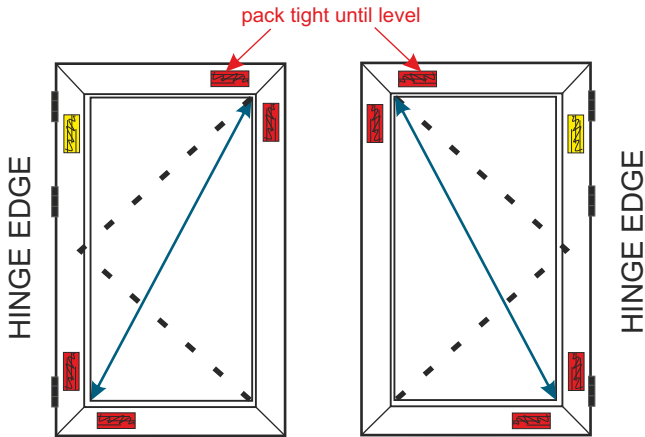

Insert Packers tightly across diagonals, ensure head is level and secure packers in place with silicone.

■ Internal hinge positions



■ Packer

■ Final fix packer

Toe & Heeling

FOLDING / SLIDING OPENING IN OR OUT:

All configurations are viewed from the Inside

Toe & Heel	
	This symbol indicates where to pack each panel.
	Final Fix Packer

1 Panel

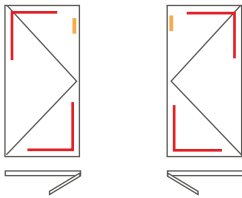

2 Panel

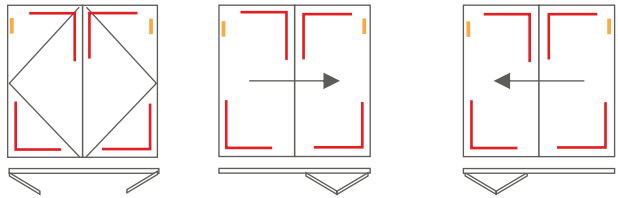

3 Panel

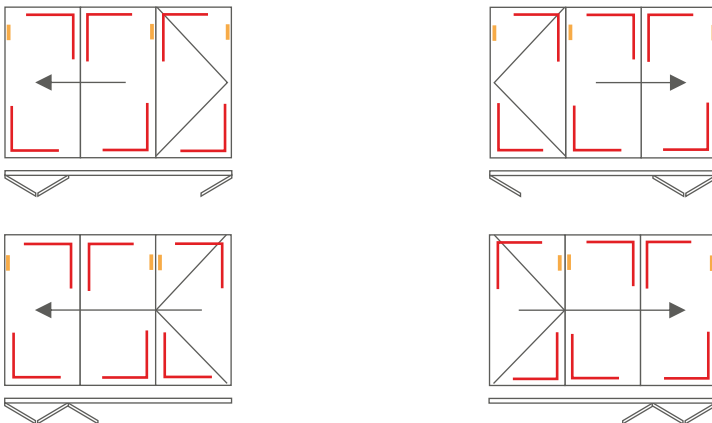

Toe & Heeling

FOLDING / SLIDING OPENING IN OR OUT:

All configurations are viewed from the Inside

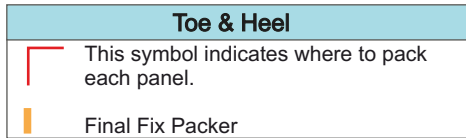

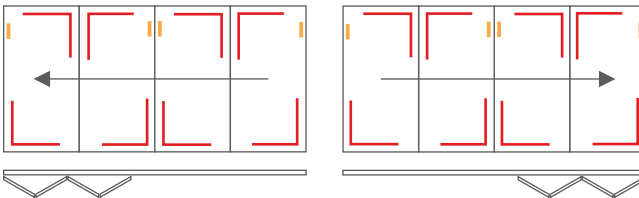
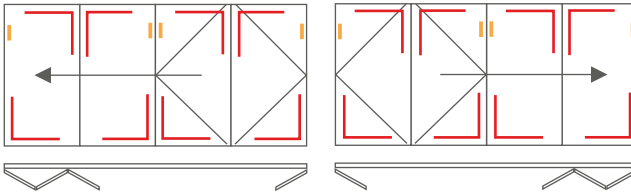
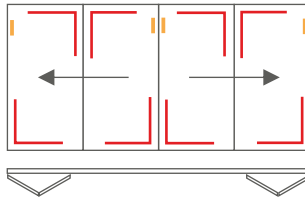

4 Panel



Toe & Heeling

FOLDING / SLIDING OPENING IN OR OUT:

All configurations are viewed from the Inside

Toe & Heel	
	This symbol indicates where to pack each panel.
	Final Fix Packer

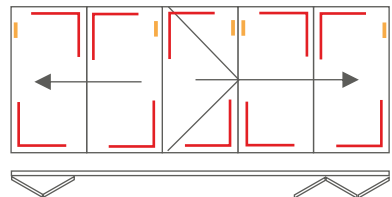
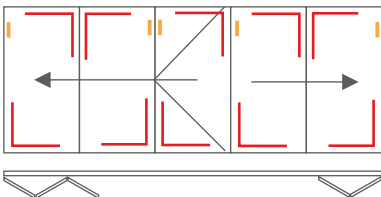
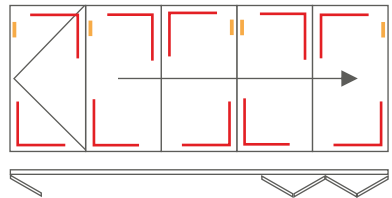
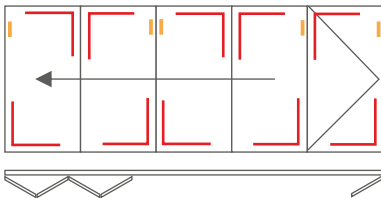
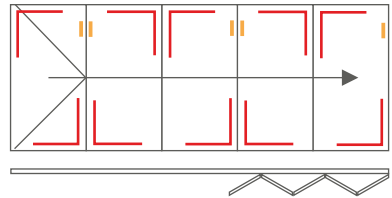
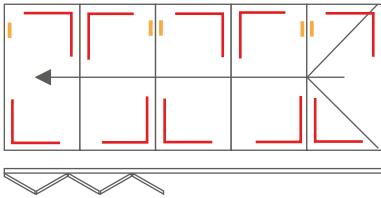

5 Panel



Toe & Heeling

FOLDING / SLIDING OPENING IN OR OUT:

All configurations are viewed from the Inside

Toe & Heel	
	This symbol indicates where to pack each panel.
	Final Fix Packer

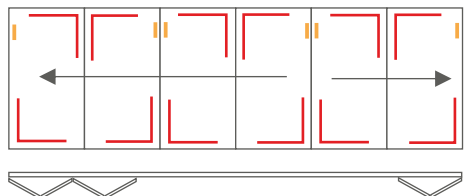
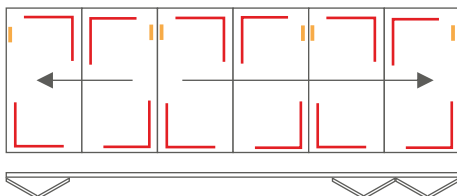
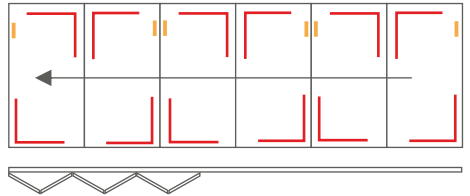
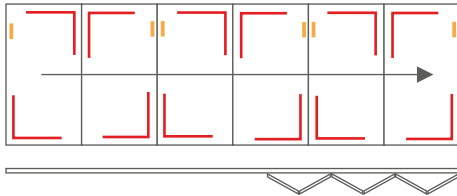
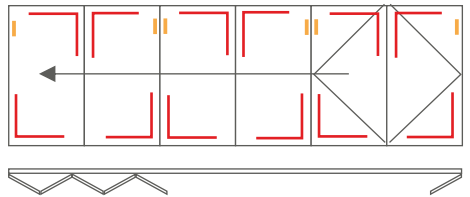
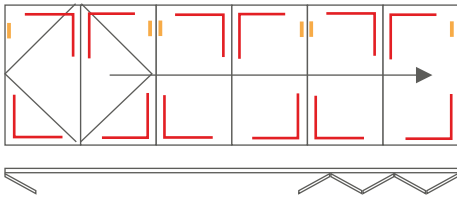
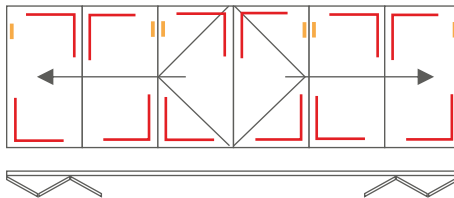

6 Panel



Toe & Heeling

FOLDING / SLIDING OPENING IN OR OUT:

All configurations are viewed from the Inside

Toe & Heel	
	This symbol indicates where to pack each panel.
	Final Fix Packer

7 Panel

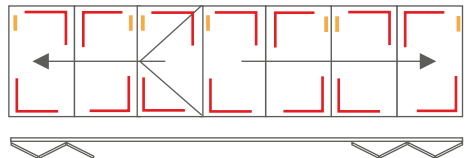
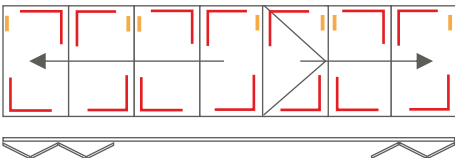
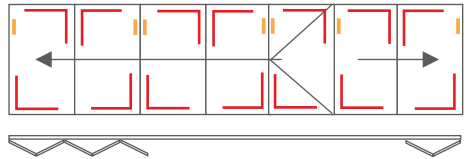
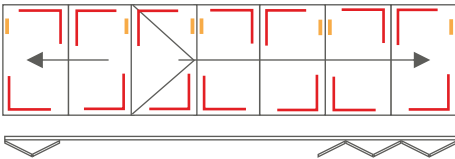
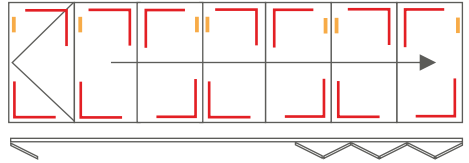
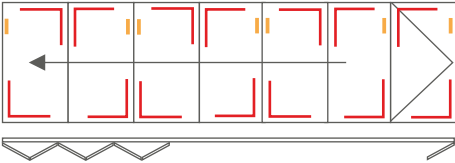
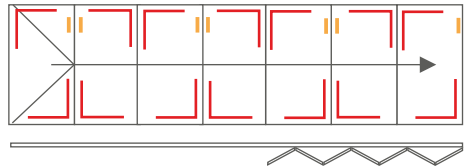
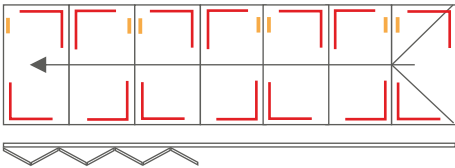

Toe & Heeling

This guide provides a detailed explanation of how we suggest to toe and heel our doors. This is for use as a guide only as each set of doors are unique and may require different levels of packing in the toe and heeling process (amount of packers used). Please use your own judgment and if unsure please contact an experienced installer or our technical department.



The red sections display where to toe and heel on a 3 panel door all one way.

The yellow sections display the final fix packer position.

Start by toe and heeling the panel attached to the frame first and work towards the traffic door (Or slave door).

The remainder of the presentation will show you how to toe and heel the traffic door.

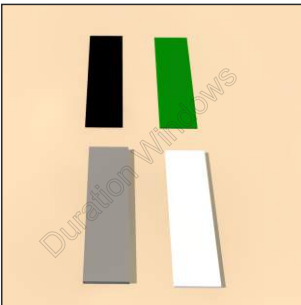

Packers are supplied in a range of sizes which are colour coded for ease of use. Packers used in this guide are an example only. Each door is unique and will require different levels of packing. Always use a range of packers to best suit the door being toe and heeled.



When toe and heeling use a glazing shovel where needed.

Toe & Heeling

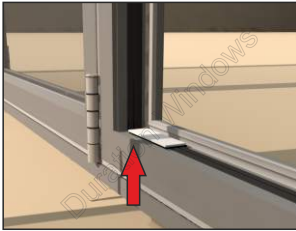

Place 2-3 packers at the bottom of the door on the hinge side.

(number of packers depends on door tolerances)



Place glazed unit into door frame.

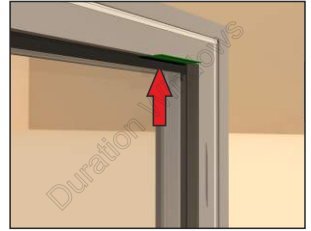

Pack the top of the unit on the handle side of the door. Use a variety of packers until the glazed unit sits firm in place.



Pack the side of the unit on the handle side of the door. Use a variety of packers until the glazed unit sits firm in place and square within the frame.



Pack the side of the unit on the hinge side of the door. Use a variety of packers until glazed unit sits firm in place and square within the frame.

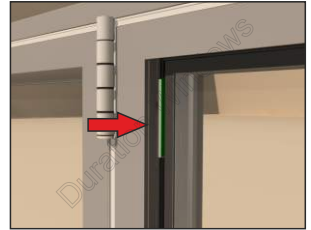

Lastly pack the top side corner on the hinge side of the door. Use a variety of packers until the glazed unit sits firm in place. This will help keep the glazed unit square and in place.

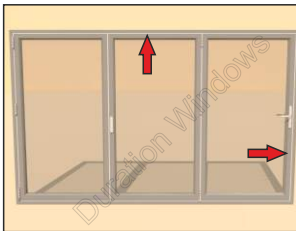

Check door is completely level with the outer frame. If not add or remove packers where needed.



Once all panels have been toe and heeled check door is running correctly and that the locking system works correctly.

If required silicone the packers on the uprights of the door into place. (this will prevent the packers from moving).

Finally clip bead into place.



DURATION WINDOWS